

Table of Contents

- Preliminaries
- Introduction
- Vessel Operations
- Fuel System
- Propulsion System
- Electrical System
- Electrical Safety
- Bilge Pumps
- Heating / Cooling System
- Fire Emergency
- Corrosion Protection
- Subsystems
- Water System
- Sanitation System
- Vessel Care
- Addenda
- Service Numbers Directory

Propulsion System



The Publisher's Statements on [page i](#) of this Owner's Manual apply to this chapter. Please read before proceeding.

This chapter gives an overview of the propulsion system and provides detailed instructions for proper maintenance, checking and troubleshooting.

Major Topics:

MAN 800 hp marine engines	28
Checks & changes	29
Tides shaft seals	29
Rexroth Mecman engine controls	30
Reverso oil changer	31
Oil & filter changes	32
Extraction fans	33
Running gear (incl. propeller torque)	34
Water lift mufflers	34
Fuel shut-offs	35
Depth finder / speed log	35
Tensioning & changing V-belt	35
Troubleshooting engine problems	36
Running on one engine	38
Engine room equipment	39

MAN 800-hp Marine Engines

Viking 61FY is equipped with 8-cylinder V90° MAN marine engines D2848LE403. All 8 cylinders are individual with their own heads. This is a 4-stroke high-torque marine diesel engine with direct injection, and turbocharged, with intercooling and wastegate. Wastegate technology gives improved acceleration capability. Bore is 128 mm and stroke 142 mm. Brake horse power is 800. The governor is mechanically controlled for maximum revs of 2300, giving the vessel a top speed of about 32 knots. Cruising speeds are 26 to 27 knots @ 2100 rpm, depending on load and sea conditions.

MAN engine specs show typical fuel consumption for each engine 22 gallons/hr @ 1800 rpm, 31 gph @ 2100 rpm, 43 gph @ 2300 rpm. The engines are designed for yachts, light duty of up to 1000 operating hours a year. Full load at maximum revs should not exceed 20%, half load 50%.

For idling and low load operations half the cylinders switch off. This reduces smoke, pollution and gives better fuel economy. Engines use high-pressure fuel injection through multiple-hole nozzles. An engine monitoring system with indicator lights and an audible alarm activates in the event of a problem.

Specs in the *MAN Fuel, Lube & Coolant Engine Manual* call for certain brands of oil and coolant – follow those recommendations!

Engine sump oil capacity is 4.8 U.S. gallons.

Chapter 1 of the MAN book includes instructions for servicing the oil level **B**, oil and filter change **C**, and coolant top-up **D**

Air filters **F** also require servicing. If airflow into the engines is partially blocked very poor performance results. Disposable paper filters are fitted as original equipment but you may wish to replace them with K&N re-useable filters. These can be cleaned and re-oiled using K&N cleaning kit #99-500.

DO NOT use compressed air to clean the filters.

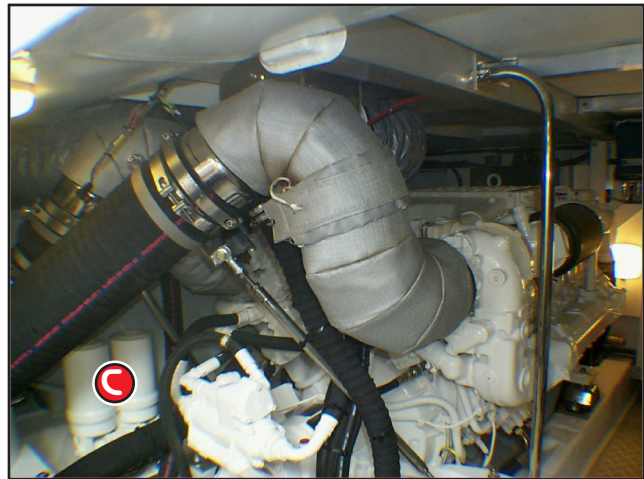
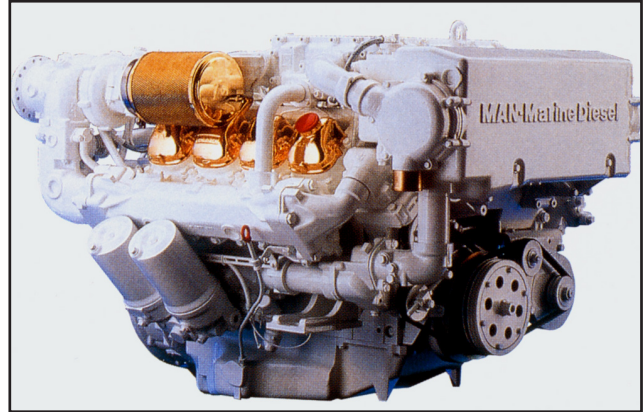

MAN manuals

Information in this chapter was drawn from these 3 MAN owner's manuals.

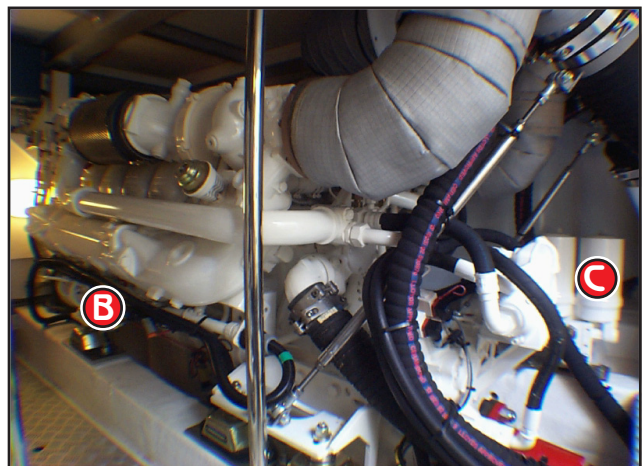
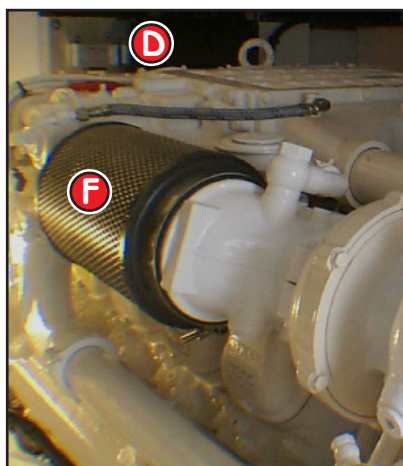

Checks & changes

The MAN *Operating Instructions* book covers fuel system secondary filter change **G**. The fuel pre-filter is also explained. Page 27 addresses bleeding and priming the fuel system with fuel priming pump **H** (see also the Fuel System chapter of the present manual). Change these items after the first 50 hours and after that at 200 hours, or yearly, whichever comes first.

The fuel priming pump plunger must be turned to pump up fuel pressure. The fuel pre-cleaner is part of this pump and must be serviced. Your MAN Diesel mechanic should do this when the oil is changed as it cannot be done without the necessary parts. There is an oil changer pump but the installed REVERSO system is easier to use (page 31).

Engines drive TwinDisc **J** marine gear model 5114A / 1.92:1. Oil level **K** must be checked daily when the vessel is going to be run. (*Note:- engine must have been off for more than 2 minutes, otherwise hot oil could burn you.*) The correct oil level is between MINIMUM and MAXIMUM on the dipstick.

Annually and/or after 500 hours of operation change the oil and replace the oil filter cartridge. At this time the zinc anodes on the oil coolers must be inspected and changed if necessary. Have your MAN diesel mechanic show you where these are.

The engine and marine gear controls are Rexroth electronic, with push/pull cables from the engine room actuator boxes to the engines and electric solenoids for gear operation.

Tides shaft seals

Check the Tides shaft seal **M** and bonding brush, **N**. The shaft must be clean and shiny under the brush. Seawater salt stains will not allow the metal graphite brush to make good electrical contact. Lift up and check that brushes are in good contact with the shaft.

The hoses **Q** going in and out of the Tides self-aligning shaft seal supply seawater from the marine gear oil cooler into the seal to cool it and also lubricate the internal shaft seal and cutlass bearings. A spare shaft seal is inside box **P**. See Tides manual for its installation. Yearly, or after an extended voyage, check the torque of the coupling bolts **O** and nuts.

The shut-off valve **R** for the engine seawater thru-hull should be opened and closed monthly to keep it freed up. If the vessel is lifted from the water these valves should be closed and remain so until the vessel is back in the water. This protects the engine impeller. The water lift mufflers **L** must also be drained before lifting.

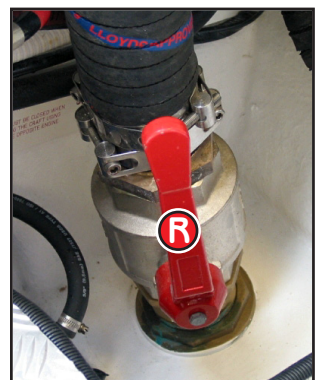
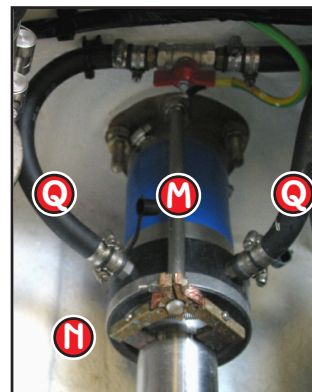
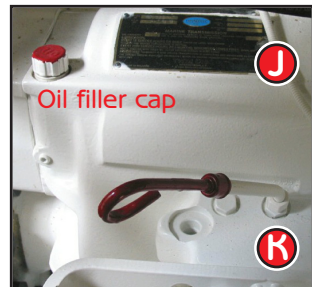
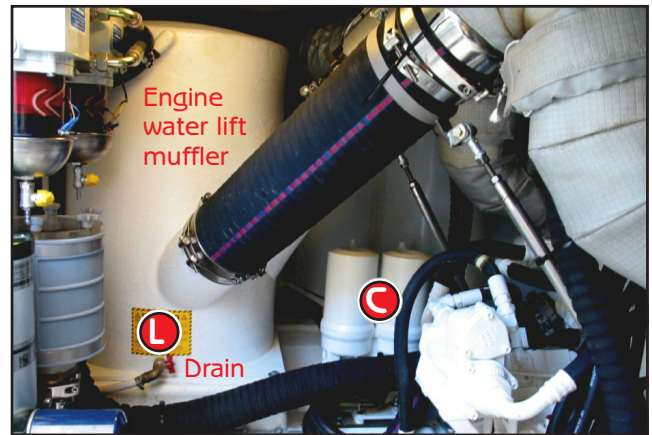
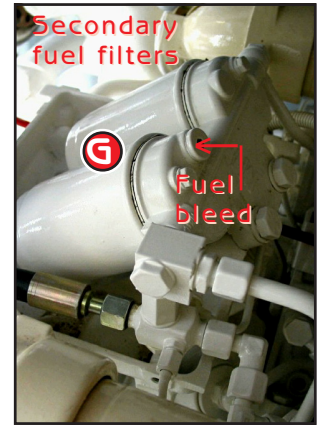
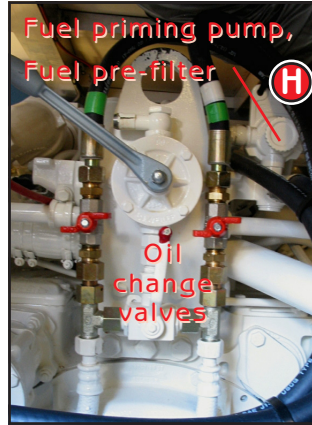

Bonding brush, **N**

Gently lift the spring-loaded brushes to check for dirt and salt stains – the shaft should be shiny.

Rexroth Mecman Engine Controls

The engine and marine gear controls are Rexroth BJ system with Type 240 control head **A**. This is a 'fly by wire' system similar to that used in aircraft and some advanced cars.

Moving the throttle control creates a signal carried electrically to the engine room control units **U** where it is interpreted and in turn operates a DC servo motor. The servo mechanically moves the engine governor, via push/pull cable, to match throttle lever movement to produce the revs required.

When engine sync is selected the governors on both engines are moved together from the port throttle lever only to achieve the same RPM on both engines.

When the control lever is moved to the AHEAD or ASTERN detente, the signal is interpreted by the actuator box which in turn operates the appropriate gear solenoid, **G**. In NEUTRAL there is no signal – zero voltage.

Emergency reverse:- If controls are moved suddenly from AHEAD to ASTERN, the engines stay in gear until engine revs drop to idle. There is a pause (up to 10 seconds, depending on speed), then direction is changed, and engines throttle up. This program protects the marine gear.

To engage controls

1. Put both Salon and Bridge control heads into NEUTRAL detente position. Start initially from the Salon helm.
2. Switch on BOTH ignition keys **E**. The POWER ON LED lights up. Engine preheat begins when ignition is switched on – the dash icons for preheat **P** will glow red.
3. Push COMMAND pad **C** TWICE. Both COMMAND lights in the status display area **D** will light. A short BEEP tone will sound, indicating you have command at this station.
4. Wait for engine preheat lights **P** to flash, then start each engine individually with the green buttons.
5. To transfer to stations bridge/salon, put control heads at both stations in NEUTRAL. Go to the new station and push COMMAND pad **C** TWICE. A BEEP will indicate you have command at the new station.
6. To engage engine sync both P & S control levers must be under command and in AHEAD at cruise range (1000 rpm to full revs). Push SYN/TROL (engage sync) pad **S**. The SYNCHRO LED in the status display area **D** will light. The port engine control is now the master.
7. To disengage sync push the SYN/TROL pad **S** once. Now, if the control head is moved out of RPM range, sync deactivates. Note:- Trolling is not used.

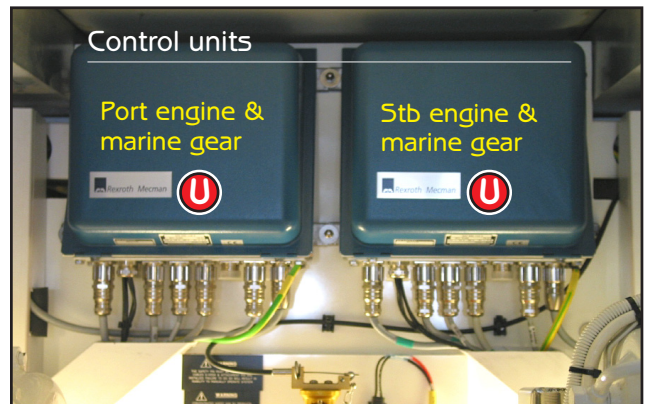
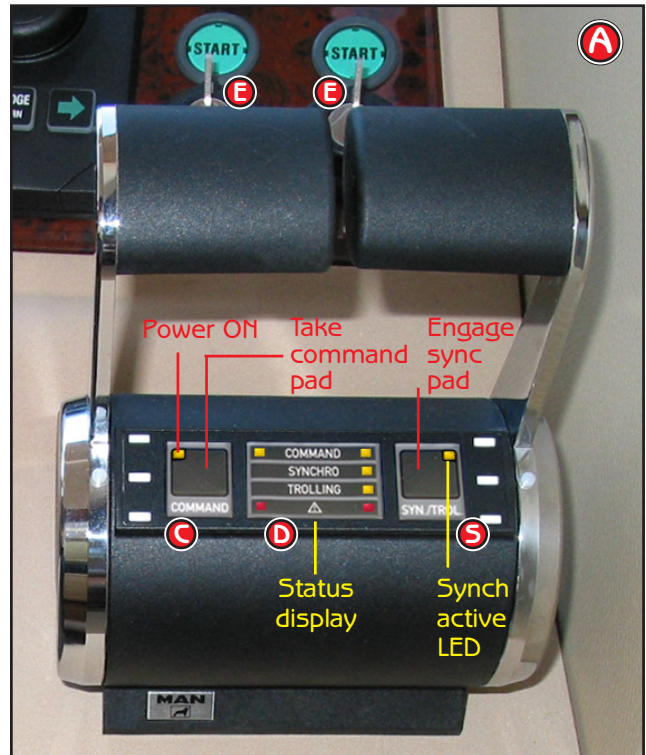

Preheat icon



Marine gear solenoids

Clutches are solenoid operated.

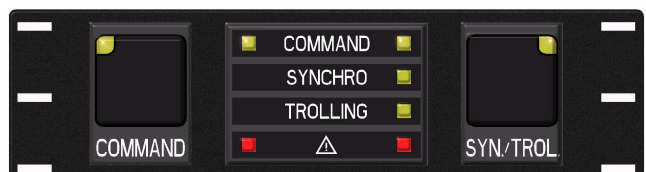

A closer look at the Rexroth panel

Reverso Oil Change System

To drain:

Note:- oil should be in the pump before you start.

- Open valves for engine sump **C**, and marine gear **D**. With diverter valve **E** select the inlet to be open. Valve handle will point in direction of OPEN valve.
- Warm up engine or generator to thin the oil. Cold oil is thick, and harder to pump out. Connect hose to Reverso outlet/inlet **O**. Have new oil ready in a bucket.
- Remove dipstick to allow air into crankcase.
- Select and open ONE correct valve **F-K** on Reverso Manifold.

To prime pump if required.

- Move switch to FILL position – this is to prime the pump.
- Pump will start and oil will enter engine, when it does, switch pump OFF – it is now primed (omit this step if not required).

To remove old oil:

- Insert end of connected drain hose into a sturdy container to receive the old oil.
- Move switch to DRAIN position. Pump will start.

To fill:

- Some mechanics prefer to fill engines with new oil through the oil filler neck. This is to ensure the sump is not overfilled. NEVER fill the marine gear with the Reverso oil changer.
- When system has been fully drained fill with new warm oil.
- Change oil filters.
- Insert pickup hose into new oil bucket. The quantity of oil should not exceed engine capacity. NEVER OVERFILL. You MUST remove any surplus or engine damage can result.
- Select port **K** or stb **H** engine; open valve to selected engine.



- Move switch to FILL position
- When working, the system should pump about 1 gallon U.S. (4 L) a minute. Try to fill while the engine is still warm.
- When near to the expected quantity in the sump, switch pump off.
- Wait for level to settle.
- Insert dipstick and check on oil level. Level should be slightly below full mark.
- Oil change for the generator is the same except that there are no valves to move on the MAN engine. It is direct to and from generator sump. As with the main engines: DO NOT OVERFILL. If engine is run with oil above FULL it can be damaged

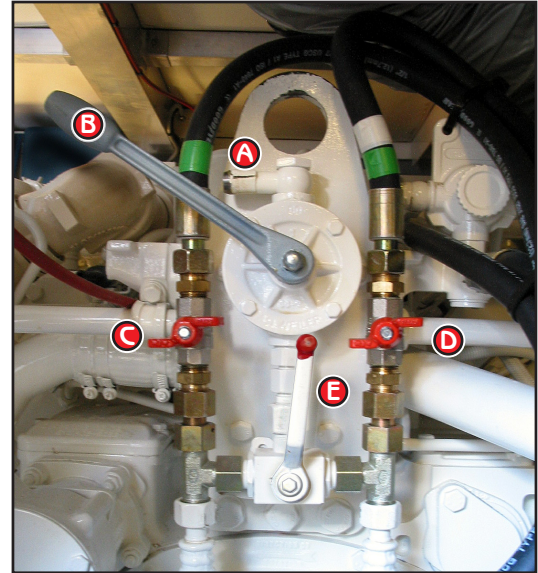

MAN manual valves

- A. Inlet/Outlet when used manually
- B. Hand pump
- C. Engine oil sump
- D. Marine gear sump
- E. Diverter valve

Lift safety cover to select DRAIN or FILL

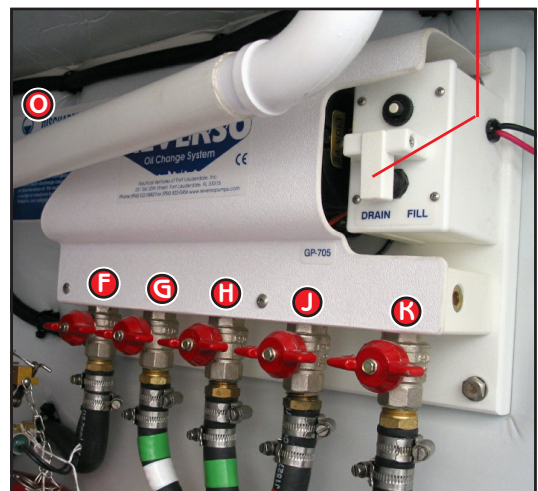

Reverso Pump Manifold

- F. Generator
- G. Starboard marine gear box
- H. Starboard engine
- J. Port marine gear box
- K. Port engine

Avoid skin contact with used oil. Hot oil can cause serious burns. Dispose of used oil responsibly. Comply with safety regulations.

Oil & Filter Changes

Engine Oil filters

The MAN books, *Operating Instructions* and *Fuels, Lubes & Coolants* describe requirements for engine maintenance and recommended products to use. Refer to those books for authoritative information. A competent diesel mechanic should change filters and oils.

Recommended Interval:- Change engine oil and filters **A** and the secondary fuel filters **F** every 200 hours, or yearly. Sample engine oil at this time and send it off for analysis.

Oil sump capacity is 4.8 U.S. gallons. See label **B** below filler cap **C**. Oil is API CD-CE either 10W-30, 20W-30 or SAE 30 or 40, depending on climate. Check the MAN recommendations.

Level on dipstick **D** should be between FULL and LOW marks. DO NOT OVERFILL. If overfilled surplus oil MUST be removed, as engine damage can result from the connecting rods aerating the oil, resulting in lubrication loss.

Use nothing but the correct MAN full flow filter element approved by MAN Diesel. Run the engines at idle for a few minutes after oil change. Check oil pressure. Check filters for leaks. For information about using the Reverso oil changer see previous page.

Secondary fuel filters

Change the two secondary fuel filters **F** when the engine oil and filters are changed. Shut off fuel on each Separ filter to change the filters. Some fuel will be lost when the filter is unscrewed so place absorbent material underneath to catch it. Use a tool to loosen filters anticlock. Then unscrew by hand and remove from boat for safe disposal.

Moisten the seal on new filter cartridge with clean fuel. Screw on clockwise then tighten vigorously by hand. Open Separ fuel valve. Open bleed screw **E** by one or two turns. Actuate hand primer pump to fill filters until fuel emerges without air bubbles. Close bleed screw. Start engine and check for leaks. The fuel precleaner may have to be stripped and cleaned also.

Marine gear oil

The Twin Disc marine gear oil level must be checked with the dipstick **G** every 50 hours of operation. Check with engine at idle and normal operating temperature. Replace oil within the first 50 hours and thereafter every 1000 hours or 6 months of operation, whichever is sooner. **Multigrade oil CANNOT be used.** The suction strainer must be removed and cleaned at each oil change. If oil comes out the breather oil level is too high; it must be corrected.

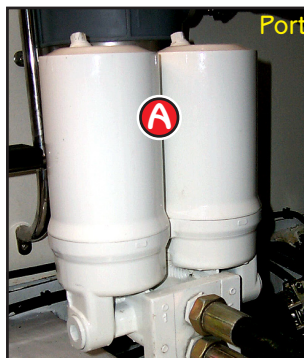

Engine oil filters, **A**

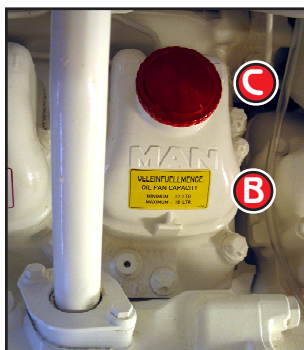

Engine oil cap, **C**

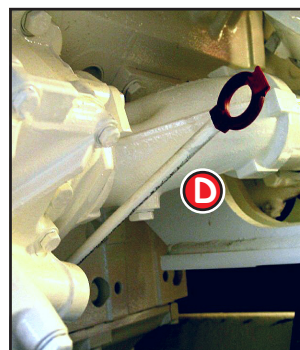

Engine oil dipstick, **D**

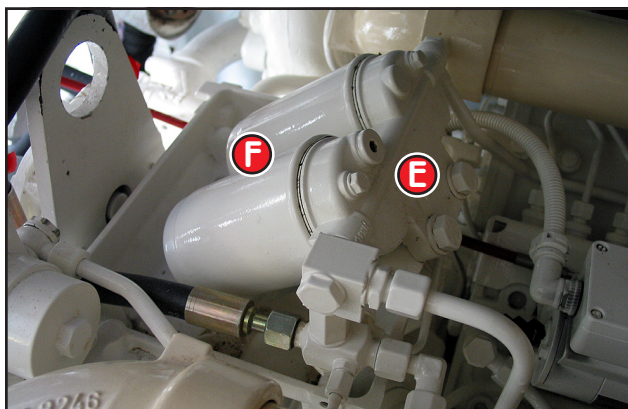

Secondary fuel filters



Twin Disc marine gear

Engine room extraction fans

When running the engines suck large quantities of air into the engine room through the hull side vents. The air passes through the MAN air filters **L** to support internal combustion. The engine also create much heat within the enclosed space. Your vessel is equipped with two high volume 24 volt extraction fans **K** to remove hot air from the engine room when necessary. These fans automatically start and run for a set period when either ignition key is turned on. They also run for a set period after engine shut down to cool the engine room.

You can extend the time they run after engine shut down, or when working on the engine room. To do this ensure that the ENGINE start battery switch is ON. Turn either engine ignition start switch ON briefly, then switch it off. This will start the fans for a new timed cycle.

The forced flow of fresh air must be cut off in the event of a fire in this compartment. Fans are automatically switched off if the fire bottle in the engine room should discharge.

Engine air filters

A diesel engine requires easy access to a large volume of clean air when at high revs. Thus, all air into the engines goes through large capacity air filters **L**. Given a clean engine room, these filters have a long life before they become clogged and need service. If you see oil on the surface of the filter it must be serviced as soon as possible. Your MAN service mechanic will do this for you. If washing an engine down, DO NOT get water on the filters. NEVER allow an engine to be run without the filter in place.

As delivered, engines have disposable paper filter elements. These can be replaced by reusable K&N filters.

The reusable K&N is a pre-oiled filter that should never be allowed to dry out. Use K&N cleaning kit # 99-500 to clean and re-oil the filter. DO NOT use compressed air, it will blow holes in the cotton filter element. Also, DO NOT use WD-40 or light oils to oil it. The filter will NOT trap dirt sufficiently unless it is oiled with special polymers as a tack barrier.

The crankcase breather filter **M** is NOT reusable. Replace it at least every two years. If exhaust smoke is blue, the crankcase breather is clogged.

Fuel tank breather filters

Racor / Parker Lifeguard fuel/air separators **N** are installed in the fuel tank air vent lines. These "spit stop" filters capture fuel splashed up the vent line by vessel motion. They separate the fuel from air and return it to the tank; only air is vented. The filters are installed in the closet below the fuel deck plates.

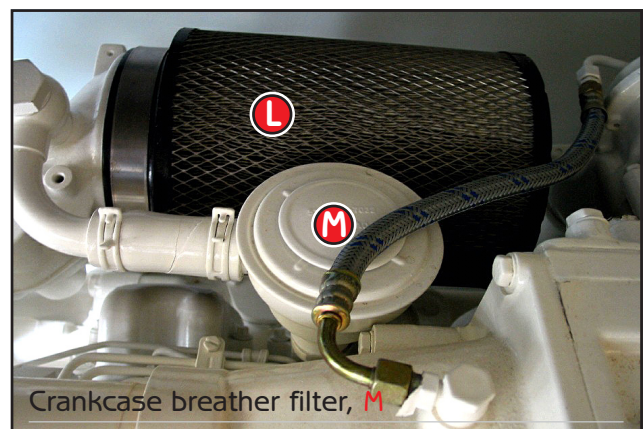

Running gear

When installing a propeller there is a correct procedure to follow.

Clean the shaft thoroughly. Attach the prop to the shaft, WITHOUT the key. Mark the shaft at the fwd face of the prop boss, then remove prop. Fit key into keyway, it should be a tight interference fit. Refit prop, making SURE it slides over the top of the key with a very small gap ABOVE the top of the key.

Attach the tab washer and nut. Push prop forward as far as it will go. Check that the forward boss face reaches the mark on the shaft. Tighten the nut by hand. Lock the shaft from turning. With a torque wrench and correct size socket fully tighten to correct torque.

Bend edge of tab washer **A** over a flat as in the photo.

Correct Torque for attaching prop nut is 500 Nm
 Shaft dia.: 60 mm. Coupling thread: M42x65 A/F.
 Prop thread: M42x3 65 A/F. Length 4,166 mm
 Engine bolt-down to bed: 133 foot-pounds.
 Propeller: Teignbridge 31x37. Aqua cup, 4-blade Nibral.

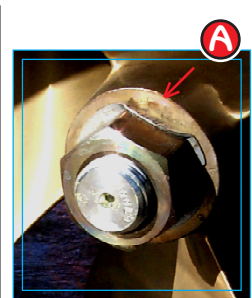

Engine water lift mufflers

Water lift mufflers for the main engines are installed on all Viking boats. They result in a very quiet running vessel, allowing normal conversation when underway. However, like all equipment, they must be monitored.

Inspect the white fibreglass for black marks. Such marks are typically the result of exhaust gas leakage due to a loose hose clamp. This must be attended to promptly, as deadly carbon monoxide gas can seep through the vessel and you may not be aware of it.

See if the bolt in the clamp is loose, using a SHORT 5-inch ratchet and a socket of correct size. DO NOT USE EXCESSIVE PRESSURE – the fibreglass piping can be deformed resulting in a serious exhaust gas leak

A water lift muffler is also installed on the Onan generator. This ensures a quiet vessel that will not disturb others in the anchorage.

Drain all water lift mufflers before lifting the boat.

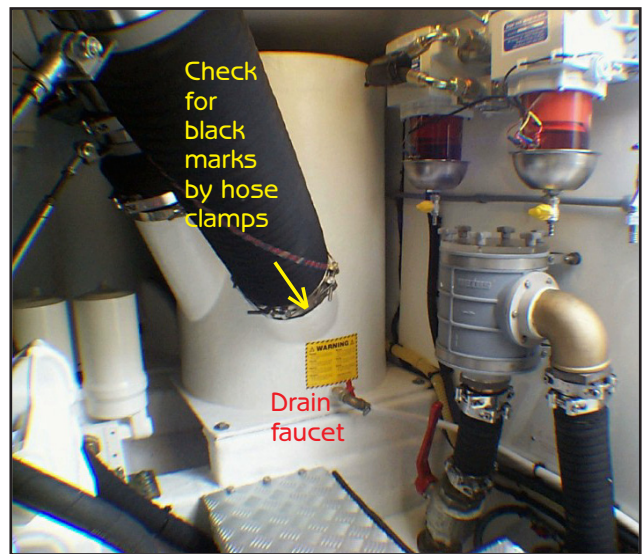

Water lift muffler

If your boat is laid up for the winter, or transported by road, the water muffler drain faucets should be left open until the boat is back in the water.

Water lift mufflers **MUST** be drained before lifting the boat. Otherwise, water in the mufflers could run into engines causing severe damage.

Fuel shut-offs

On top of each fuel tank are remote fuel shut-off valves. The port main tank has one; the stb main tank has two shut-offs: **A** is for the generator, **B** is for the stb engine.

The shut-offs are operated from inside the utility locker on the stb side of the cockpit **C**. Normally they are pushed in (i.e. open, as shown); when pulled out, they are closed.

If the vessel is being left for some time, or taken out of the water for extended servicing, the fuel valves should be closed, but put a very visible sign on the helm to ensure no one will attempt to start the engines or generator. For more details see the Fuel System chapter.

Cockpit locker:- The photo at right shows the fuel valves share the stb locker with the emergency manual bilge pump and manual activation triggers for the Sea-Fire extinguishers. Pull red handles **D** to discharge engine room or lazarette fire bottles. The handles connect by cable **E** to the discharge valve on the fire bottles. For more information see the Fire Safety chapter.

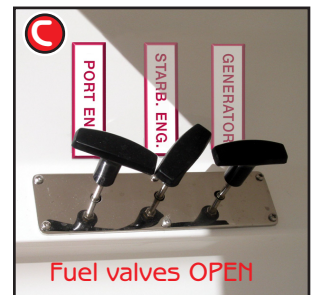
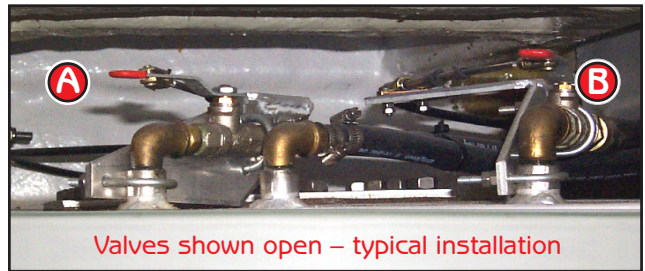

Remote fuel valves

Except in emergency, **DO NOT** shut off fuel when the engines are running.

Depth finder / speed log transducers

Aft of each engine is a transducer: **F** is the depth finder; **G** is the speed log.

The stopper hanging nearby is to plug the hole if a transducer needs to be pulled for cleaning.

Whenever the vessel is removed from the water for service inspect the transducers for dirt or sea growth that could result in incorrect readings. Do not paint the fittings on the hull.

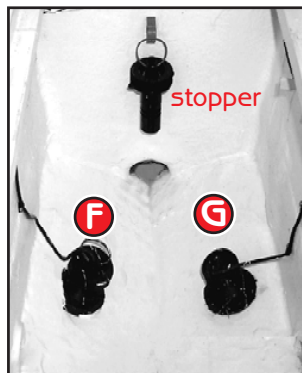

Tensioning & changing V-belt

The 120 amp 24 volt alternators are generally maintenance free. However to maintain full output at high engine revs the belt must be kept at correct tension.

Switch off master switch for engine start battery.

Test belt for tension:-

Apply an UPWARD force under the belt **J** of about 25 pounds. The belt should deflect a maximum of 1/2 inch. If it deflects more, the belt needs to be tightened.

To tighten belt:-

Loosen nut **H**.

Turn setting bolt **K** clockwise to increase belt tension – **DO NOT OVERTENSION**. Check for correct deflection. Retighten nut **H**.

To change belt, turn bolt **K** anti-clockwise until belt is loose enough to be removed. Fit new belt and adjust for correct tension. Retest tension after several hours of running.

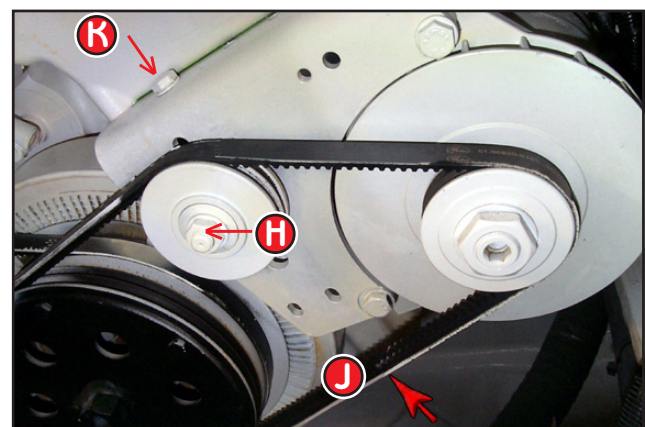

Alternator belt tension

25 pounds of upward pressure at the midpoint should cause the belt to deflect no more than 1/2 inch.

Troubleshooting

Engine will not stop

With a four-stroke design, diesel runaway is highly improbable. Normally, switching the IGNITION KEYS **A** to OFF and pressing the red STOP buttons **B** will stop the engines. Failing that, pull out the remote fuel shut-off **C** to stop the runaway engine.

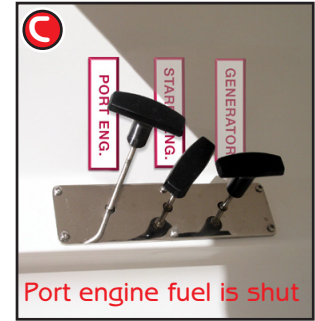
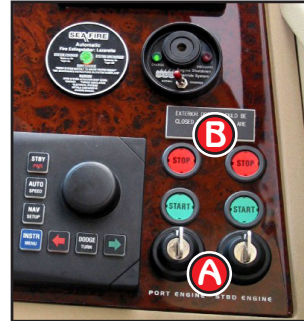

Port engine fuel is shut

Engines will not start

Low voltage:- If one engine, or both, will not even turn over, *but you can select the Rexroth controls*, engine start battery voltage may be low. Check that voltage **V** on START BATTERY VOLTS meter reads over 23 volts.

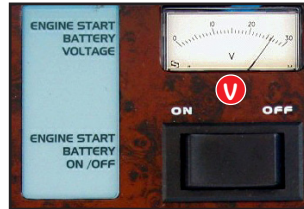

Fire or false alarm:- The Sea-Fire system could have tripped. *Make sure there is no active fire!* Check that fire bottle has not discharged, the needle is on green and the glass phial intact. Normally, if a fire occurs the engine room blowers will be shut off. If fire is not the problem, the switch on the Sea-Fire panel can be moved to OVERRIDE **R** to eliminate the system as a possible problem. This, however, defeats the ignition safety system and the fault must be located as soon as possible.

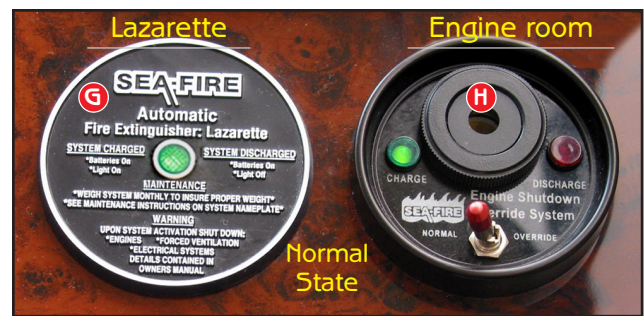

Sea-Fire panels

Green light is normally ON, on both engine room and lazarette displays, when battery 24V power is on.

Engines will not respond to controls

If the engine is running but you cannot select FORWARD or REVERSE on one engine, the most likely problem is a tripped circuit breaker for the Rexroth controls. Inside the DC distribution cabinet, port-side lazarette, check 16 amp breakers numbers 92 and 93 **T** to see if they have tripped.



Rexroth breakers – DC distribution cabinet

Breakers 92 & 93 should be on. If one of them has tripped the Rexroth control will be unresponsive.

Signals from the Rexroth helm control head are fed to the port or starboard Control Units **U** in the engine room. These contain servo motors to actuate throttle position and marine gear selection. There are no owner-serviceable parts in here but you can observe if the servos are responding to the controls. This may help to pinpoint a problem.



Rexroth control unit

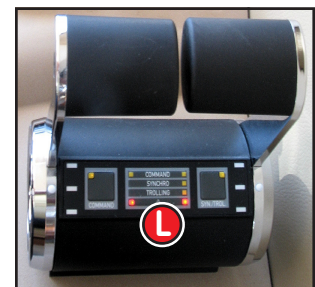

Rexroth alarm display

A Rexroth alarm display must not be ignored.

If a problem develops with the throttle look at the servo motor and make sure that it is moving the lever without any obstructions.

If the red fault lights **L** blink and an audible alarm sounds on the control head (except during start up when this is normal as a test procedure) immediately check your instruments and panel display icons for the source. An alarm will likely precede an engine shut down.

Both engines stop while underway

This is an unlikely occurrence and should be easy to troubleshoot. If the Rexroth alarm did not sound, and the fans are still running, the likely cause is a fault in the Sea-Fire system – an electrical connection may have corroded, or come loose. Check connections at Sea-Fire relay box **S** behind the Salon helm (access is via the removeable panel in the stb cabin headliner).

A loose or broken connection in the two-wire circuit **C** from the engine room fire bottle to the Sea-Fire relays will likely cause a Sea-Fire shutdown of BOTH engines, but with no accompanying alarm state. If the problem is intermittent, caused by vibration, the engines will simply start again normally, but the problem will recur.

If, when the engines stopped, the green CHARGE light remained on, this is a good indication of a false alarm – a real alarm would certainly discharge one of the bottles and the red DISCHARGE light would be on.

Even with an apparent “false” alarm, ensure there is no smoke or fire in the engine room, or the lazarette. If there is neither, switch the Sea-Fire alarm to the **OVERRIDE** position **R**. This will bypass the shutdown relays until the problem can be resolved.

There is a difference between the engine room and lazarette fire bottles:- either can activate a Sea-Fire alarm, but only the engine room bottle precipitates shutdown of engines and blowers.

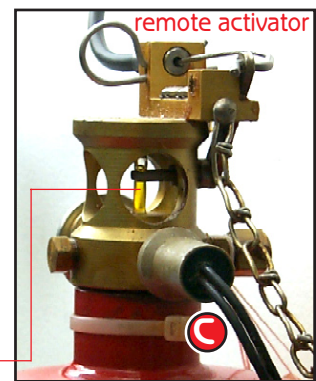
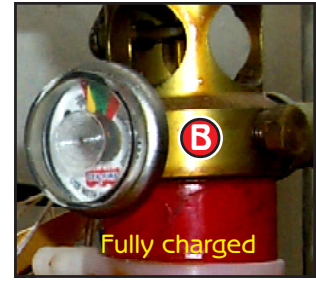

Glass phial breaks if discharged

Sea-Fire status and override

It is safe to switch to **OVERRIDE** if:

- **THERE IS NO FIRE**,
- the red discharge light is **NOT** lit,
- the bottle gauge **B** is on green (fully charged).

Under override the engines should restart and keep on running. However, **OVERRIDE** defeats the ignition safety system and the fault must be corrected as soon as you reach a marina.

Engine loses revs underway

If engines surge at high revs, but not when you slow down, the problem is likely fuel related.

- Is there plenty of fuel in the tank(s)?
- Are the remote fuel valve handles **FULLY** down?
- Is a Separ filter clogged? Switch the selector lever to the other in the pair, or to the center position for maximum flow.
- Is correct filter element in place? It is possible a mechanic mistakenly installed a 2 micron filter in the Separ filter instead of the specified 30 micron type. If so, it will quickly become clogged and not pass through enough fuel at high revs.
- Other possibilities:- The Separ filters may need backflushing (see Separ manual). The MAN secondary fine fuel filter may be clogged. You may have got poor fuel at the last fill up.

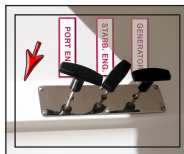

Separ filter selector

If selector handle is in this position only **ONE** filter is in use. At sustained high revs fuel flow may be insufficient. Move handle to center position to draw from both filters.

Running on one engine

If it happens that one engine cannot be started, or it cannot be run, you can proceed on one engine at slow speed to a nearby port. However, precautions must be taken. The boat's movement through the water will turn the propeller on the stopped engine. This in turn rotates the transmission (marine gear) and, over time, it will heat up. The Tides shaft seal will also heat up and destroy the seal, allowing seawater into the boat.

To protect the shaft seal:-

There is a valve **A** on the cooling water hose leading into the seal **B**. Close this valve **on the stopped engine** while running on the other. Vibration builds up as you increase speed, so it is advisable to proceed at displacement speed.

To protect the marine gear:-

The gear will heat up, but for a maximum 8 hour run it will not be a problem – it will require re-lubing however. Turn the engine on and off several times to re-lube the clutch pack **BEFORE** you leave the dock.

For a long run:-

If the 8-hour maximum run will be exceeded, you must physically stop the shaft from turning, say by jamming a 2x4 or pipe between the coupling bolts **C** and the hull.

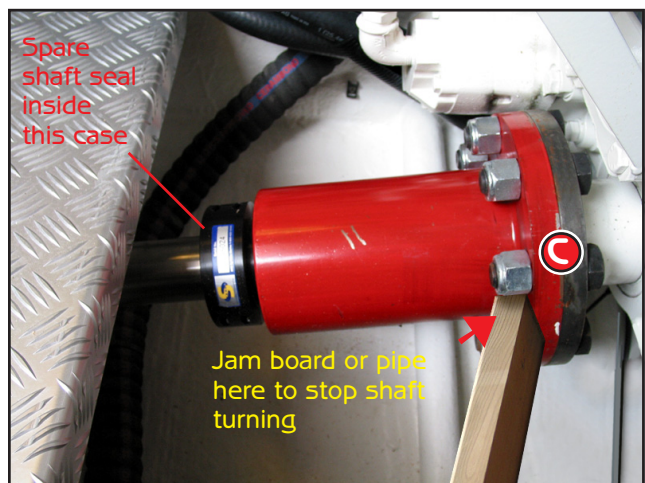
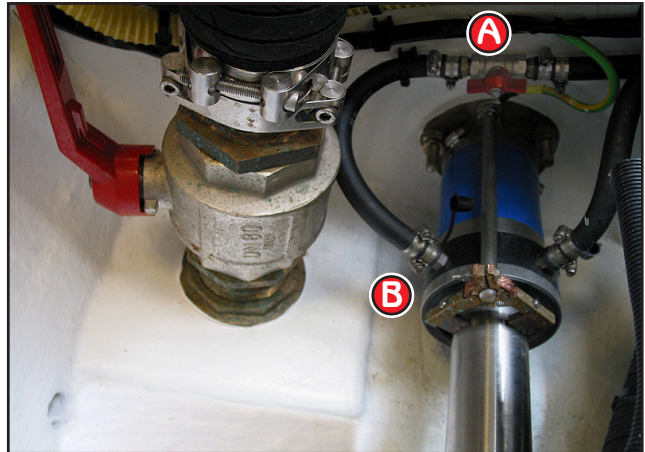

RUNNING ON ONE ENGINE

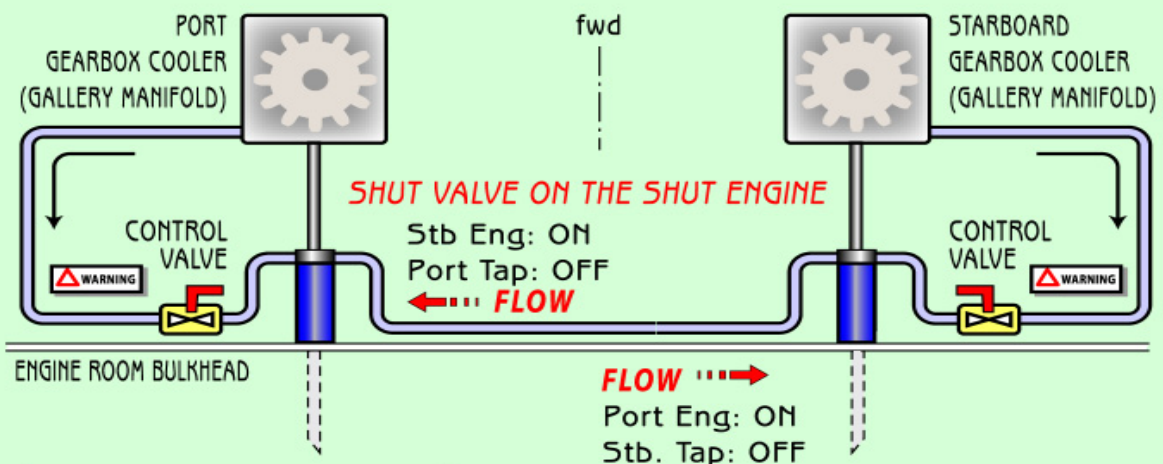

WARNING
THIS TAP MUST BE CLOSED WHEN OPERATING THE CRAFT USING ONLY THE OPPOSITE ENGINE

Note:- Shut-off valves are fitted 12 - 18" from the gearbox.

Engine Room Equipment

Raw water pickups & strainers

Marine diesels require vast amounts of free-flowing water to maintain proper cooling. Thus it is vital to keep an eye on the seawater pickups and strainers. Valve handles **V** should be 'worked' at least monthly to keep them moving freely. Strainers **S** need to be checked for accumulated debris before starting, and checked for adequate flow after starting. Also check hoses and clamps.

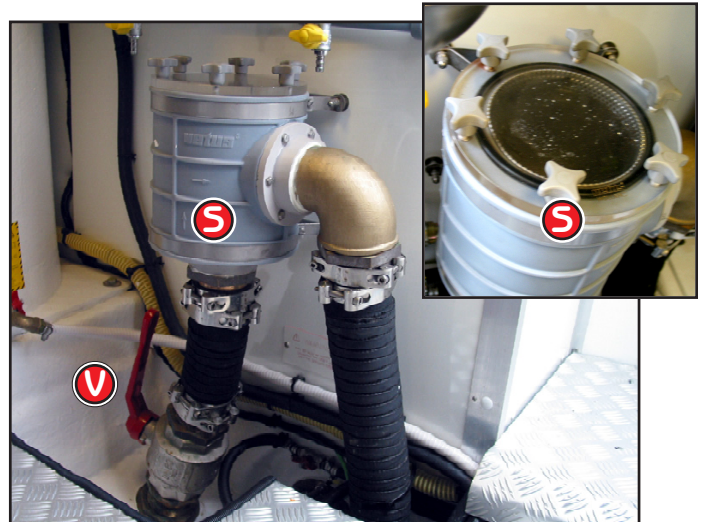

Bilge pumps

There are two bilge pumps in the engine room, one fwd, one aft. Test them regularly as part of your pre-voyage inspection. It is inevitable that engine room bilges will collect some fluid from service procedures such as cleaning strainers. The manual bilge pump, pickup **M**, is handy for housekeeping small spills as it clears water to a lower level than the electric pumps. However, residual water should be cleaned up with a large sponge or wet vac.

Keep bilges clean and be vigilant for leaking oil or spilled fluids. The cold water tap on the aft engine room bulkhead is for washing down bilges. But oil or antifreeze *must not* go overboard – you can be charged for pollution. If faced with contaminated bilge, switch off the electric pumps (secondary breakers 4 & 5) then pump the contaminated water into a pail and dispose of it safely.

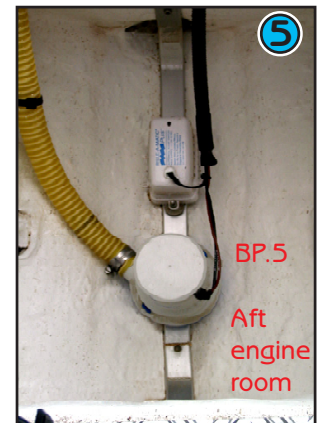
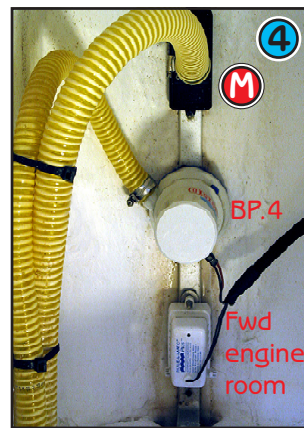

Cleaners:- *Sudbury Bilge Cleaner* is a good choice for bilges. If the engine has to be cleaned, *Simple Green* works well and is biodegradable. Do not get water onto filters.



Sea-Fire extinguisher

Make a habit of checking that the needle **G** on the Sea-Fire discharge head is on green and that wires and cables are secure. A loose wire here can stop the engines.

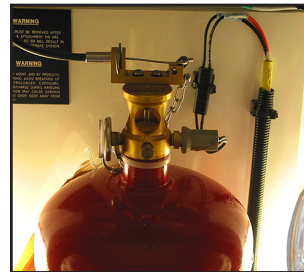

The Sea-Fire is very effective at extinguishing fire but the gas discharged is toxic. DO NOT ENTER THE ENGINE ROOM OR LAZARETTE until the spaces are thoroughly vented with fresh air. This will take at least 20 minutes.

Also be aware that, depending on the nature of the fire, the products of extinguished combustion can leave an acidic residue. Avoid skin contact and clean as soon as possible.

Other items

In general, all engine room equipment requires at least general surveillance to note for leaks, or chafing of hoses, wires and cables. There must be no loose parts or tools.

